



2.1

HYDRAULIC PILOT REMOTE CONTROL JOYSTICKS

Type : HL-4TH

Benefits:

- Progressive, sensitive operation
- Low actuation forces
- Low force deviations when lever is actuated
- Several ergonomic grips with various E contacts
- All connections point downwards



Contents

	Page
Features	03
Section view	04
Technical data	05
Ordering code	06
Fuction symbol	06
Control ranges	07-09
Unit dimension	10

Features

1. Structure

- Integrated body, stable and reliable in work
- Control characteristic constant
- Sealing structure with dustproof

2. Applications



Excavator



Tractor Loader Backhoes



Wheel loaders



Cranes

Section view

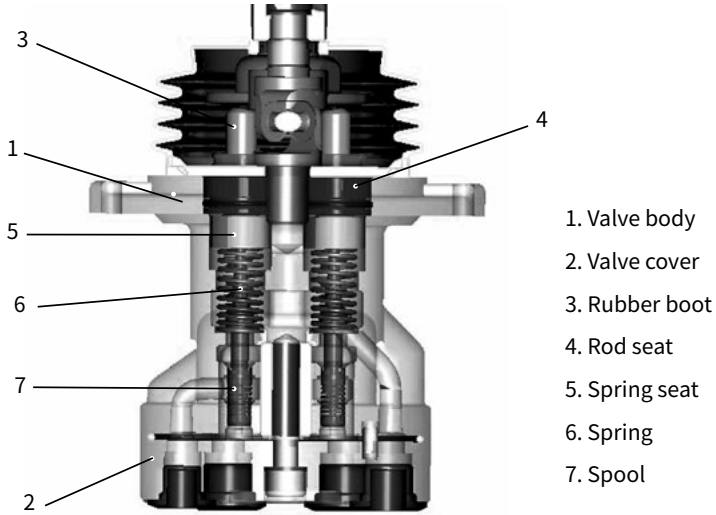

Technical data

Working medium	Hydraulic oil
Pressure fluid temperature range	-20°C ~+90°C
Viscosity range	10~380 mm ² /S
Inlet pressure	69bar
Back pressure at port T	≤ 3bar
Pilot oil flow	≤ 20L/min
Fuction symbol	(Figure)
Control range	(Figure)
Switch Type	
The specified electricity is loaded	DC30V 5A, AC125/225V 5A

Ordering code

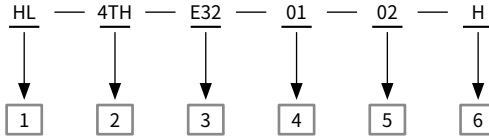

- 1 HL Company is called HL for short.

- 2 4TH 4 way multi-way valve.

3

E32 The handle according with human engineering design, means the left handle, with horn symbol, rod bending 15 degrees to the 3 port, the handle to the 2 port.

E12 The right handle, without symbol, rod bending 15 degrees to the 1 port, the handle to the 2 port.

Notes: The mounting position of the handle relative to the port can be assembled according to the customer's requirements.

- 4 01 Control ranges 01 (figure);
 02 Means control ranges 02 (figure).

- 5 02 The size of inlet, outlet and working port is G1/4
 03 The size of inlet is G1/4, outlet and working port is G3/8

- 6 Seal:
 H Cold-resistant seal element
 R Hot-resistant seal element
 Ellipsis The normal seal element

Fuction symbol

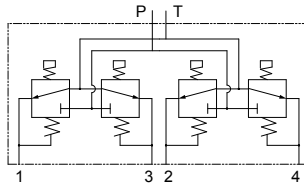

Control ranges

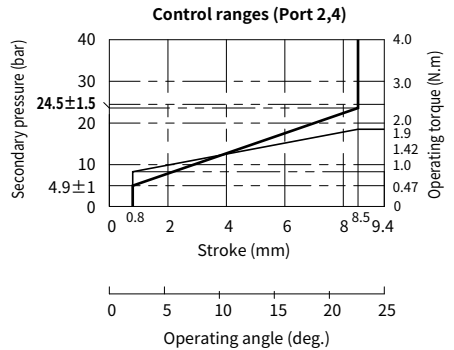
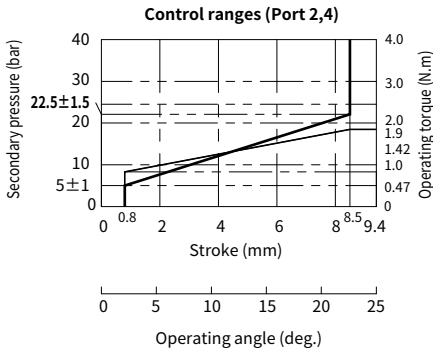
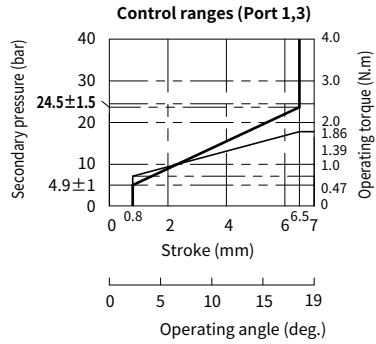
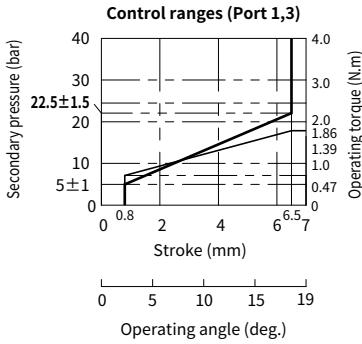
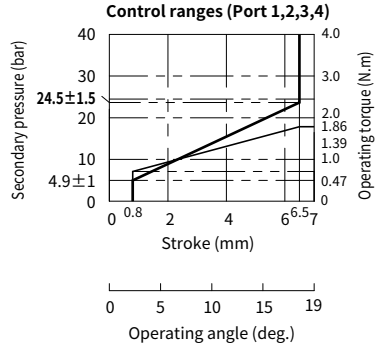
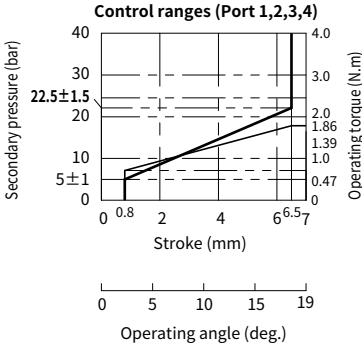

02

Control ranges

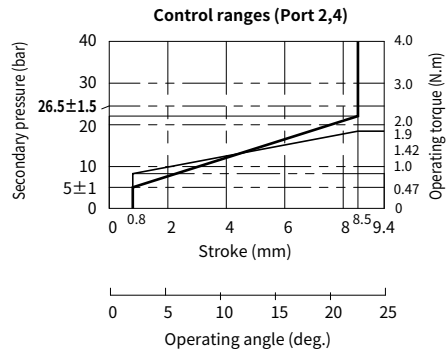
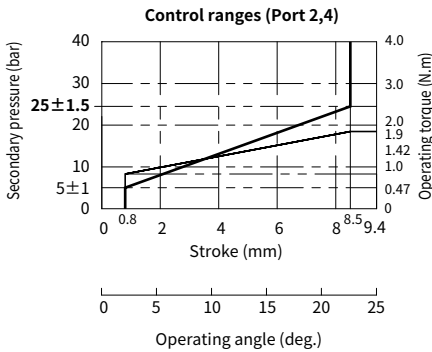
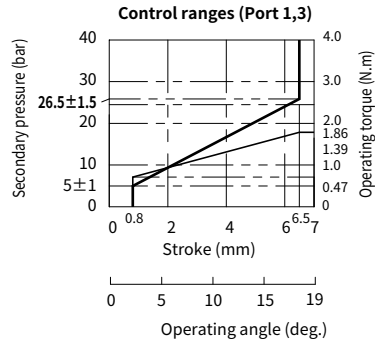
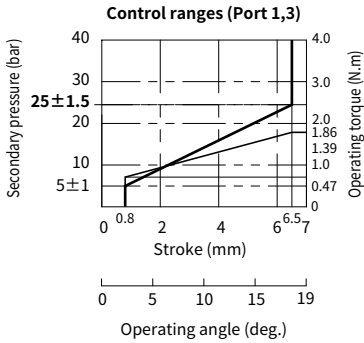
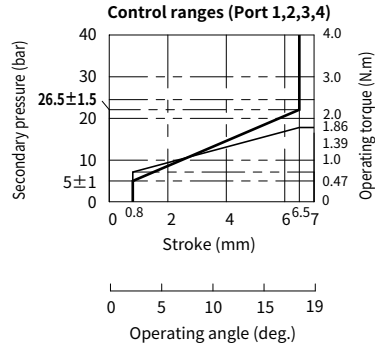
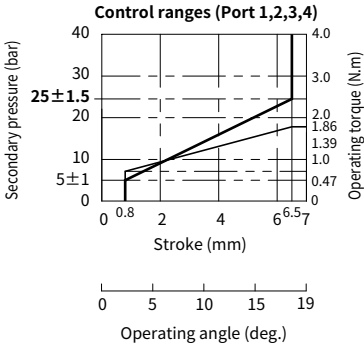

Control ranges

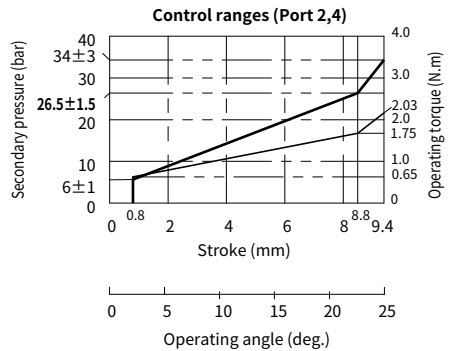
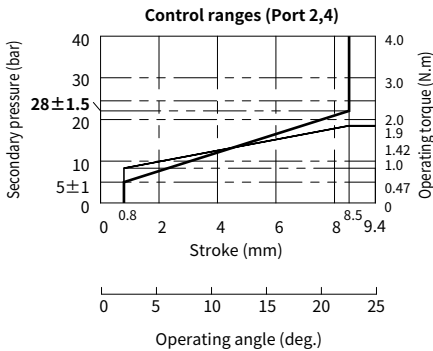
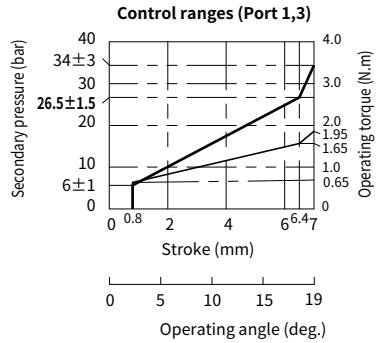
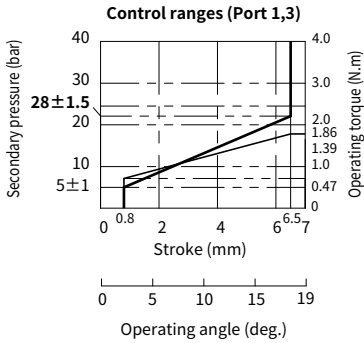
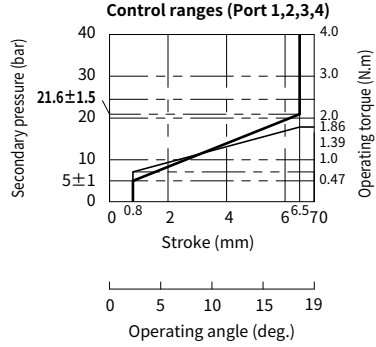
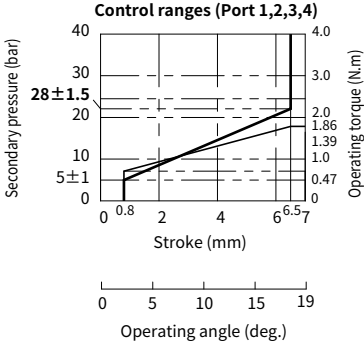

02

